



GAS FUELED STOVES

User Manual and Warranty Card (EN)

Thank you for your trust and purchase of the freestanding stove. This device has been designed for your safety and comfort. We would like to express our conviction that you will be satisfied with your choice because of the commitment that was involved in the design and production of the gas stove. Prior to installation and use, please carefully read all of the chapters in the manual. If you have any questions or concerns, please contact our technical department. Any additional information is available online at www.fram-gmbh.de.

Introduction

FRAM GmbH is a well-known manufacturer of heating equipment in both Poland and Europe. Our products are based on strict standards. Each stove manufactured by the factory is subjected to quality control during which it undergoes rigorous safety tests. The use of the highest quality materials in the manufacture ensures smooth and reliable operation of the device by end users. This manual contains all of the information necessary for proper installations, operation and maintenance of the Freestanding STOVE AB S.

NOTE!!!

Installation, inspection and maintenance of the tightness of the device can be carried out only by qualified fitters/technicians with licences appropriate for the given region.

Introduction

Freestanding STOVE AB S are closed heating equipment powered with flammable gas. This device is CE marked and uses high-end automation to control gas. Stoves meet the stringent European directives with regard to safety, the environment and energy consumption.

The air supplied to the combustion chamber is drawn from outside of the housing via a coaxial chimney system. This solution provides the user with security because it prevents passage of exhaust gases directly into the room where the stove operates. Before fitting the stove, please read these instructions. The information contained herein will allow you to obtain trouble-free operation of the device. This manual should be retained for the lifetime of the stove.

Product description

The Freestanding STOVE AB S are designed to be supplied with natural gas (NG) or liquefied propane-butane (LPG). The units may be available in four versions, depending on the type of glazing. Freestanding STOVE AB S are equipped with automation and security of the same type. Regardless of the model, how it is connected to the gas system and the flue system is identical.

This manual, including all photographs, illustrations and trademarks, is protected by copyright. All rights reserved. The manual and any materials contained within it may not be reproduced without the written permission of the author. The information in this document is subject to change without notice. The manufacturer reserves the right to make corrections and modifications to this manual without obligation to inform anyone.



Rys. 1. RO/Ggas stove

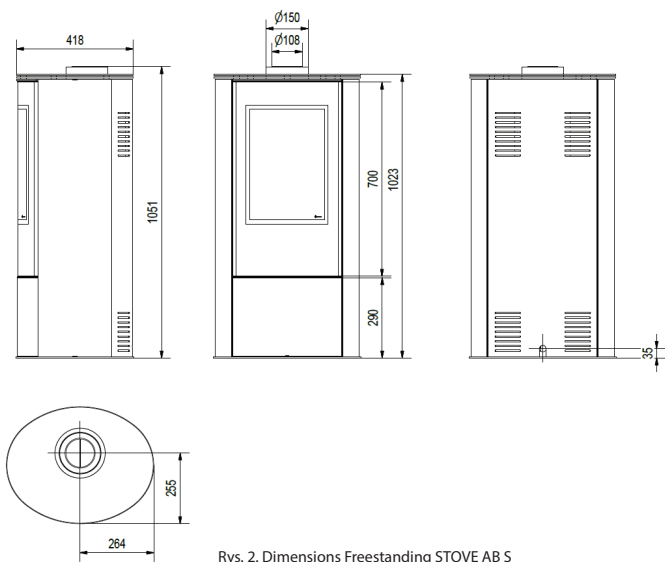

Rys. 2. Dimensions Freestanding STOVE AB 5

Gas group		Nominal connection pressure	Destination
I _{3B/P}		30 mbar, G30	BE, CY, DK, EE, FR, GB, GR, HU, HR, IT, LT, NL, NO, RO, SE, SI, SK, TR
		37 mbar, G30	PL
		50 mbar, G30	AT, CH, DE, FR, SK
I _{3P}		30 mbar, G31	FI, NL, RO
		37 mbar, G31	BE, CH, CZ, ES, FR, GB, GR, HR, IE, IT, LT, NL, PL, PT, SI, SK
		50 mbar, G31	AT, CH, DE, NL, SK
I ₃₊		28-30/37 mbar, G30/G31	BE, CH, CY, CZ, ES, FR, GB, GR, IE, IT, LT, PT, SI, SK, TR
I _{2H}		20 mbar, G20	AT, CH, CY, CZ, DK, EE, ES, FI, GB, GR, HR, IE, IT, LT, LU, LV, NO, PT, RO, SE, SI, SK, TR
I _{2H}		25 mbar, G20	HU
I _{2E}		20 mbar, G20	DE, PL, RO
I _{2L}		25 mbar, G25	NL
I _{E+}		20/25 mbar, G20/G25	BE, FR

Set components

Please make sure that the set components were not damaged during transport. The inspection should be carried out in the presence of the fitter. Before installing the stove, please learn all of the elements that came with the device. In the case of any damage or omissions, please contact customer service. The user receives a set including:

- GV60M1 Mertik Maxitrol controller.
- B6R-R8U Mertik Maxitrol receiver.
- 8 - symbol B6R-H8T5B remote control.
- Clamp connector 8 mm.
- Clamp connector 6 mm.
- One-piece clamp connector 6 mm.
- Screw plus 3/8" - 2 pcs.
- G60-ZUS09 interrupter block.
- Control burner block G30-ZP2M.
- Control burner nozzle - NG (number 27_2) LPG (designation 22)
- Seal under the control burner block.
- Thermocouple G30-ZPT1500A.
- Magneto wire.
- Cables connecting the interrupter block with the receiver.
- An 8-core cable connecting the gas controller with the receiver.
- Reducing nipple 1/2, ' to 3/8, '.
- Gas connection cables having a diameter of 6 and 8 mm.
- Distribution box.
- Power module G60-ZBE (Option).
- The cable connecting the power module with the receiver, 90° (Option).
- Lighting control module and a G6R-BEAV2 fan (Option).
- The cable connecting the G6R-BEAV2 module with the receiver (Option).
- 10-unit symbol B6R-H8TV14B remote control (Option).

Safety

Carefully read the following information:

- Connecting a stove to a gas installation and its maintenance can be carried out only by a qualified fitter or a service technician of heating gas appliances.
- If the control flame goes out, wait for at least five minutes before trying again.
- It is strictly forbidden to make any modifications in the design of the gas stove.
- Gas control system components must not be exposed to moisture.
- Do not operate the unit without inserting its glass.
- Do not touch hot parts of the stove, in particular, the glass.
- While children or other unaware persons are near a working unit they should not remain unattended.
- It is forbidden to place decorative elements used for the lining of the combustion chamber in front of the control flame.
- Do not place flammable materials near stove.
- It is prohibited to place combustible materials in the combustion chamber. If you feel gas leakage, do not operate the unit. As soon as possible, shut off the gas, ventilate the room where the stove is and contact your service representative.
- Any cracked glass should be immediately replaced.
- In the case of malfunctioning, cut off the gas supply and contact your service representative.

Installation

Freestanding Stove is equipped with protective devices against uncontrolled outflow of gas from the main burner. Before connecting the appliance, please read all connection diagrams given in this chapter. The gas stove is adapted to be connected to a special coaxial chimney system allowing simultaneous supply of fire into the air and flue gas discharge to the outside of the building. To ensure proper operation, installation of the stove can only be done by qualified persons with appropriate licences.

Prior to the release of gas to the stove, the fitter should:

- Perform a leak test for the gas connections.
- Check the correctness of joining the components of the system.
- Check for proper connection of the stove to the chimney system.
- Perform test kindling in the stove.
- Check the correct operation of all components and system security.

Rules

Install in accordance with local standards and regulations in force in the Member State or the region. Connection to the chimney, wall and roof passages and all kinds of items used to install the stove should be done in accordance with applicable standards of construction law.

Freestanding stove has been tested according to PN-EN-613 CIndependent gas-fired convection heaters.

Location

Before connecting the device to a gas pipe and chimney, carefully choose the location of the device. The stove should be positioned so that the combustion air installation had the minimum number of bends. This will ensure appropriate chimney draft. It is also important that the flexible wires connected to the gas stove were not exposed to excessive bending. Stove must be at least 60 mm away from combustible building elements (Fig. 3-4). The temperature of the walls exposed to direct fire cannot be higher than 80°C. Under no circumstances should you place the device in the hinterland of combustible materials, such as wooden furniture, carpets and curtains. Due to the possibility of ignition, it is prohibited to dry clothes, towels, etc. in the hinterland of the gas stove. Stove must be installed on a stable non-flammable surface. The gas stove is equipped with special adjustable feet and two adjustable mounting brackets allowing for attachment of the device to the wall. Never install the gas stove on the back or the side wall. Installation is permitted only in the vertical direction.

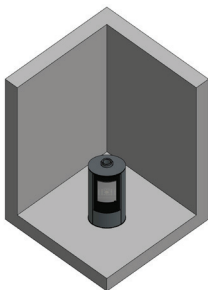

Figure. 3. Location of the gas stove from the flammable housing components.

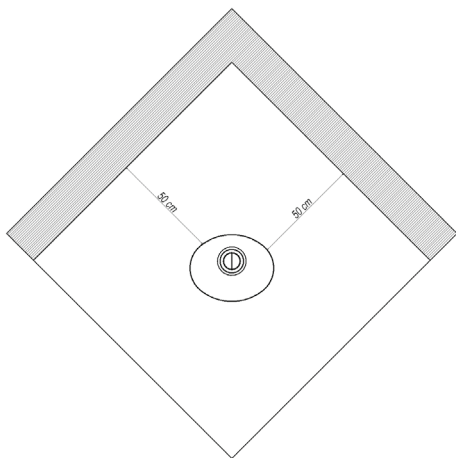

Figure 4. The minimum distance of the gas stove from the flammable housing components.

Connecting the device using a coaxial combustion air system

Installation must be in accordance with local building regulations. It is recommended to pass the flue pipe through the wall of the building by the use of 1 meter vertical section, angle 90° and a maximum of 3-meter horizontal section. In the case of stoves with linear LPG burners, it is recommended to use a 1 meter vertical section, a 90° elbow and a maximum of 2 meters of a horizontal section. The connection between the device and the coaxial cable must be sealed with high-temperature silicone. All ducts cannot be insulated. In the case of flue passage through the external wall of the building:

- Install the system in accordance with the applicable regulations, including any difficulties related to the wind pressure on the terminal.
- In the case of flammable walls, provide an additional distance of 5 cm between the wall and the outer surface of the coaxial cables. The remaining space is to be filled with protective insulation against the ingress of moisture into the building.
- If the flue pipe is close to combustible walls, protect them with thermal insulation at a minimum distance of 25 cm.
- Installation of the coaxial system installation begins at the outlet of the stove 1 meter vertical section (the minimum height).
- Individual elements of the system should be connected by means of special clamps to ensure proper tightness.
- In the case of necessity, individual components of the system should be stabilized using wall mounts.

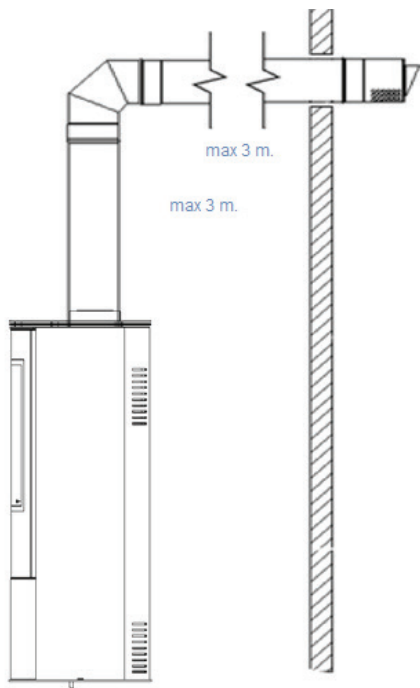

Figure 5. Coaxial system output method

Gas stove are designed for a specific combustion air supply. The chimney system used to connect the Freestanding STOVE AB series is based on elements consisting of two coaxial conductors, wherein the outer diameter of 150 mm is responsible for providing air to the combustion chamber and the internal diameter of 100 mm for the discharge of exhaust gases. The concentric line must end with a special cap to allow proper operation of the system.

The coaxial cable should be terminated with a special thimble allowing for proper operation of the system. All system components must have the required approvals and CE certificates. Freestanding gas stove AB Series has been tested using a coaxial - air combustion system. In the event of condensate in the air-flue pipe, the fitter should apply a drainage element (droplet eliminator).

Installation of the control system

NOTE!!!

The device with its gas control system can be installed only with its factory settings. At this stage, do not install the battery in the receiver. Earlier connecting to a power supply may cause damage to the electronics system.

NOTE!!!

Individual gas control system components, connect according to the diagrams provided in this manual.

The standard gas control system includes a MaxitrolMertik GV60 controller and a B6R-R8U receiver from which an antenna enables operation of the device using a remote control. Remote control gas components should be installed in the connection box. The connection box must be installed in an accessible place for possible repair or replacement of individual components of the system. Exposure of the electronic system to temperatures exceeding 60°C will result in irreparable damage. Elements of the control system should be installed in a place where the temperature does not exceed 25°C. The maximum distance between the control box and the gas stove is determined by the length of the cables connecting the GV60 gas control with the electrode and thermocouple. Do not extend the cables provided with the unit, as this may affect the control system malfunction. Keep in mind not to put the ignition cable too close to the metal parts. Contact of the ignition cable with the receiver housing can cause damage. Components of the system may not be exposed to moisture, dust, and factors affecting the formation of corrosion. Freestanding STOVE AB can operate only with the gas control system supplied with the unit. When replacing individual components of the system, use only original parts available for purchase from the manufacturer. Plugs of individual wires are chosen in such a way as to prevent incorrect connection of components.

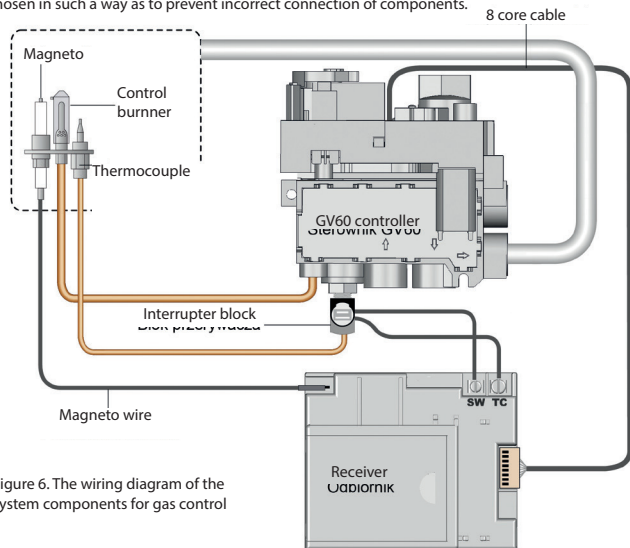

Figure 6. The wiring diagram of the system components for gas control

Passing individual wires through the casing of the gas stove, pay close attention to how they are sealed. Sealing is achieved by means of special bushings and heat-resistant paper. Other elements should be sealed with high-temperature silicone.

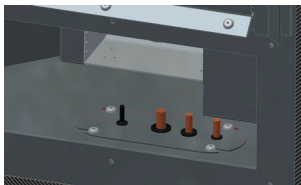

Figure 7. The way of routing out and sealing the capillary cable, the magneto wire, the tube of the main burner and the tube of the control burner

DISASSEMBLY OF THE DEVICE

In order to gain access to the individual components of the automatic gas control system used in the AB GAZ heater, first remove the top cover and then unscrew the side wall screws. After loosening the screws, lift the side panels (Fig. 8). Then remove the bottom cover. The bottom cover is fitted with four M5 screws (Fig. 9).

In order to have access to the combustion chamber, main burner and control burner module, remove the door by unscrewing the 8 M5 screws as shown in figure 10. Next, remove the inner glass by loosening the pressure strips (16 M5 bolts). Removal of the inspection is possible by unscrewing 6 screws with M5 (Fig. 11).

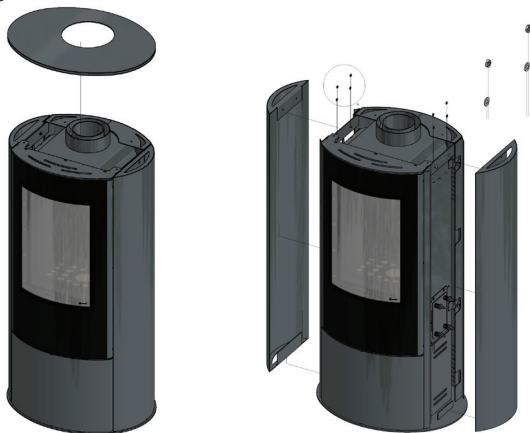

Figure 8. Removal of the top plate and the side panels

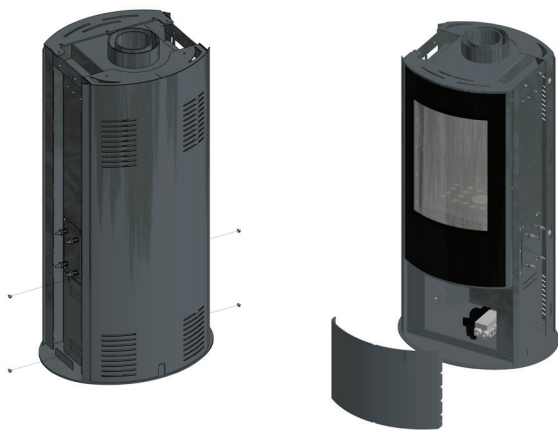

Figure 9. Removal of the bottom cover

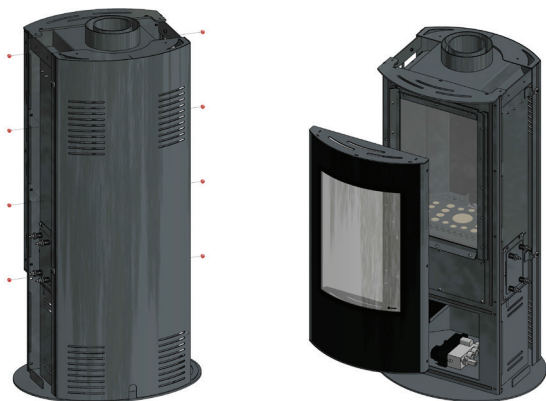

Figure 10. Removal of the doors

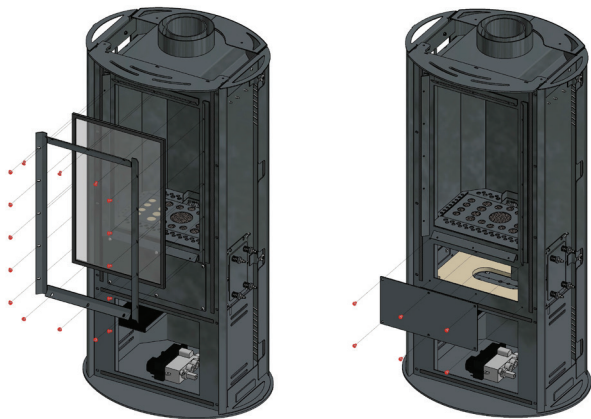

Figure. 11. Disassembly of the inner glass and revision of the stove

CONNECTING THE DEVICE TO THE GAS INSTALLATION

NOTE!!!

Depending on the type of the NG / LPG, an appropriate nozzle must be mounted in the control burner block. As standard, the unit is equipped with a burner adapted to natural gas (NG). In the case of connecting the stove to an LPG-powered system, please contact your dealer for replacement of the main burner with the right one.

WARNING!!!

The main burner module used in gas appliances in the stove consists of two parts connected to the outlet of the GV60 controller by a tee.

NOTE!!!

All activities associated with connecting the device to the gas installation should be carried out with the power disconnected. The stove installation can only be done by a qualified fitter/ technician with appropriate licences.

NOTE!!!

It is absolutely forbidden to use open fire during the installation process of the gas stove. Failure to follow instructions could result in fire or explosions, causing severe damage, bodily injury or even death.

Technical specifications of the gas control system used in the freestanding stove

PRESSURE DROP/CAPACITY	2009/142/EEC oraz DIN EN 298, DIN EN 126, DIN EN 13611
FUEL	Gaseous fuels of the first, second and third family, according to PN-EN 437:2003+A1:2009 PN-EN 613:2002+A1:2004
PRESSURE DROP/CAPACITY	2,5 mbar for 1,2 m ³ /h
ADJUSTMENT RANGE	Class C, according to EN 88
ADJUSTING THE REGULATOR	5 do 40 mbar (0,5 do 4 kPa)
MOUNTING POSITION	the module cannot be mounted with the breaker block downwards. The control position can be adjusted in the range from 0° to 90° relative to its home position
MAXIMUM PRESSURE OF INPUT GAS	50 mbar (5 kPa)
MAIN GAS INLET CONNECTION	Reducing nipple 1/2" na 3/8"
CONTROL BURNER CONNECTION	M10x1 for a pipe of 6 mm
DISCHARGE OF THE MAIN GAS INLET AND OUTLET	From the side or bottom
MAXIMUM TIGHTENING TORQUE	inlet and outlet connection $\frac{3}{8}$ " : 35 Nm Control burner connection: 15 Nm
THERMOCOUPLE /BREAKER BLOCK	M10x1, M9x1, M8x1
IGNITION	Piezoelectric ignition
ALLOWABLE TEMPERATURE LIMIT	Controller: 0 °C to 80 °C Receiver without batteries: 80 °C Odbiornik z bateriami: 55 °C Pilot: 60 °C Przewód zapłonowy: 150 °C

The gas control system used in the freestanding stove AB series meets the requirements for appliances burning gaseous fuels in Directives 2009/142/EEC and DIN EN 298, DIN EN 126, DIN EN 13611. The system can be supplied with a gaseous fuel, second and third family according to PN-EN 437:2003+A1:2009 and PN-EN 613:2002+A1:2004.

First, make sure that the connected device is intended to be supplied with the type of gas contained in the gas installation. All the necessary information about the required parameters of the gas can be found on the nameplate of the stove. Before connecting the gas supply pipes, it is necessary to purge them to remove metal filings and other contaminants from their interior. The automatic gas control should be protected from moisture and dust. These factors may cause irreparable damage to individual components. Gas supply pipes to the stove should be equipped with a ball valve of 1/2 inch in diameter. Individual elements of gas installation cannot be sealed using a Teflon tape or PTFE tape (Please use the sealing elements supplied with the unit). If the gas installation needs to be connected to a settler, install it according to Fig. 12. The settler protects the controller from gas contaminants.

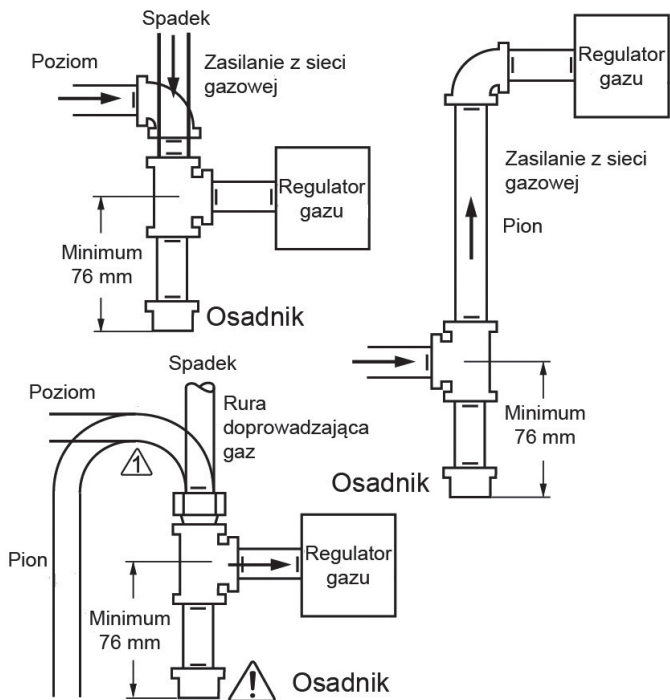

Fig. 12 How to install a settler (if required)

Fig. 13 shows the GV60 controller at its home position with the breaker block pointing downwards. The module cannot be mounted upside down. The control position can be adjusted in the range from 0° to 90° relative to its home position (also vertical). Please note that all unused gas inlets or outlets should be protected with suitable plugs.

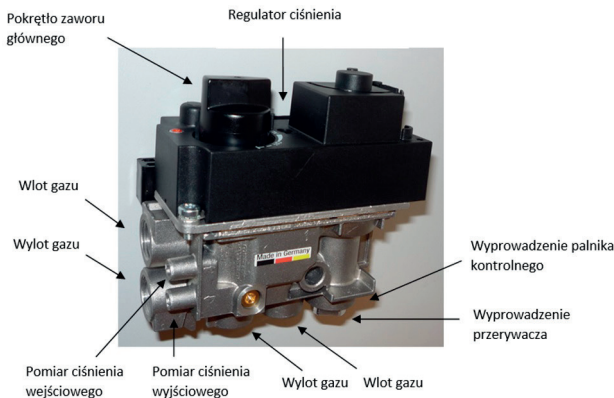

Figure 13. The GV60 controller in its home position

NOTE!!!

You may not remove screws on the enclosure. Do not connect the gas controller, if the marking paint, located on the components has been damaged.

Flame height control

Flame height control is factory set to the maximum and requires no manual adjustments. The thermocouple head should be within the control flame.

Adjusting the gas outlet pressure

1. Connect the pressure gauge to the measuring point of the output pressure. To do so, first remove the metal stove located in the control enclosure.
2. Startup the device.
3. The pressure regulator is in the upper part of the controller enclosure. To enable the adjustment, remove the plastic cap (Fig. 12).
4. Turn the regulator screw to set the desired pressure value of the main burner (high flame). To increase the pressure, turn the regulator screw clockwise or decrease it by turning the screw counter-clockwise.
5. After setting the pressure, secure the screw by installing a plastic plug.
6. If you do not need to make any other adjustments, remove the gauge and secure the port of the measuring point.

If, despite the adjustment, the desired pressure was not achieved, check the pressure of the gas supplied using a gauge connected to the measurement point of the input pressure. If the inlet pressure is within the normal range, replace the controller; otherwise take the necessary steps to ensure proper gas pressure.

If, despite the adjustment, the desired pressure was not achieved, check the pressure of the gas supplied using a gauge connected to the measurement point of the input pressure. If the inlet pressure is within the normal range, replace the controller; otherwise take the necessary steps to ensure proper gas pressure.

Regulator ciśnienia

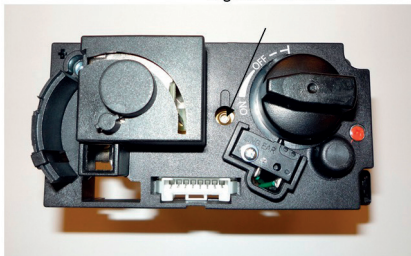

Figure 14. Adjustment method of the discharge pressure

WARNING!!!

Locking the pressure regulator is realized by the maximum tightening its adjusting screw.

Adjusting the minimum flame height of the main burner

1. Set the main valve knob to „OFF”. Turn it clockwise until valve opening.
2. The minimum flame height of the main burner can also be adjusted by tightening the adjusting screw (Fig. 13). The adjustment screw is set so as to provide the maximum flame height.
3. Turn the screw clockwise to reduce the minimum height of the flame.
4. Depending on the version of the controller, the minimum flame height of the main burner can be set at the factory by the manufacturer or can be adjusted by the installer.

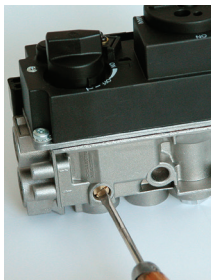

Figure 15. Adjusting method for the minimum flame height of the main burner

Adjustment of the GV60 controller to supplies of various types of gas

The GV60 controller can be adapted so that it can work with specific types of gases. Gas pressure control and minimum flow are performed according to the instructions above.

Tightness test

After connecting the system to the gas network it is essential to check the tightness of the connections made with a special sensor. In the case of leaks, shut off the gas supply shut-off valve and repeat the steps involved in installing various parts of the system.

Power supply connection

NOTE!!!

Connect the power supply only after connecting the combustion air system and any gas control system components.

The B6R-R8U receiver is powered by four 1.5V AA batteries. Pay special attention to locate the wiring connecting the gas control and the receiver away from hot parts of the stove. The need to replace the batteries in the remote control is indicated by the indicator displayed in the upper right corner of the display, while short beeps periodically appearing for three seconds immediately after starting the firing process in the stove indicate the need to replace the batteries in the receiver. Used batteries located in the receiver can overheat, spill or even explode. Do not use batteries that have been exposed to the sun, moisture, heat or vibration. Install only batteries of the same type and the same manufacturer. Do not install new batteries with worn ones. The kit can optionally include the G60-ZB90 power module. This module is powered by four 1.5V AA batteries and should be connected directly to the receiver in the place of the AC adapter connection. The additional power supply module eliminates the need for batteries in the receiver. Optionally, customers can buy a cable connecting the interrupter block and the receiver for the gas control system, equipped with a switch. The switch also protects the system against uncontrolled flow of gas through the controller.

INSTALLATION OF THE OPTIONAL WI-FI MODULE

If you install the optional WI-FI module into the receiver, connect the AC adapter. The adapter is an optional component and can be purchased from the manufacturer of the heater. The power supply unit should be CE marked. Before connecting the power supply, make sure the battery in the controller is removed. (See page 34.) The WI-FI module and power supply should be connected by qualified personnel. Technical specification required for the power supply:

- Input voltage: 100-240V (50 / 60Hz)
- Current 0.2A
- Output voltage: 6VDC (1000mA)
- Connector 2.1x5.5 mm, polarization (+) inside (-) outside

Removing the glass

ATTENTION !!!

Removing the glass should only take place off cooled stove with gas supply off and disconnected power supply.

UThe device is equipped with a heat-resistant glass that withstands temperatures up to 800°C. To replace glass first, remove the cover, the side grilles and unscrew the door as shown in Figures 9 and 10 and then remove the window by unscrewing the clamping plates mounted with (6 M5 screws).

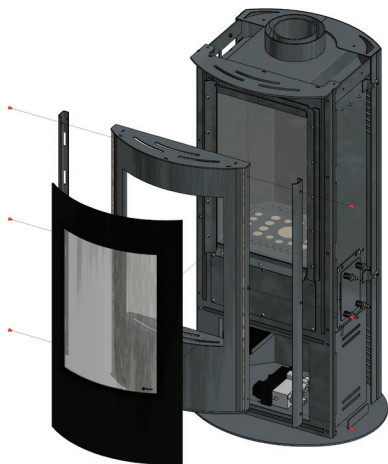

fig. 16 Procedure for removing the glass

NOTE!!!

The manufacturer recommends the use of decorative elements, optionally supplied with the device. FRAM GmbH is not liable for damages resulting from the use of decorative elements other than recommended.

The combustion chamber, depending on the user's preferences, can be lined with one of several sets of decorative elements. The decorative elements are made of non-combustible material. The use of flammable components in the device is forbidden.

To mount decorative elements, it is needed to be remove the front glass only. The elements should be arranged in such a way as not to obscure the flame control and the burner outlet openings, otherwise it may cause incorrect operation of the stove. The main burner of the stove is equipped with spacers to facilitate correct placement of decorative elements. Distribution of the elements in the combustion chamber of the device should allow the free flow of air around the main burner and the control flame. The ceramic elements should not touch the glass, as it may cause damage. Correct and incorrect placements of decorative elements are shown on pages 41

Initial start-up

Before the first use of the stove, make sure that all connections of individual elements of the system were made in accordance with the instructions. Incorrect cabling of the gas control system can cause damage.

The first few start-ups can contribute to smell which may persist even several hours after operation. This is a phenomenon caused by paint burning. Pets and birds can react sensitively to secreted fumes. To speed up the process of the paint burning, warm the stove for a few hours, setting the maximum height of the flame. If, during the first fire, there is sediment on the inside of the glass surface, remove it using a glass cleaner. The first operation of the gas stove must be carried out within a well-ventilated area.

When heating using gas you may encounter staining walls and ceilings. It is caused by the convection movement of air and thus dust particles contained therein. A partial solution to this problem is frequent ventilation of the room in which the gas stove operates. If the stove is installed in a new building, you should wait at least 6 weeks before lighting it for the first time to remove construction moisture from the walls, floor and ceiling.

Operation

Freestanding gas stoves are controlled wirelessly with a remote control. The system, as standard, is powered by four 1.5V batteries installed in the receiver. Short cyclical signals appear for about three seconds when you try to ignite the gas stove and it is necessary to replace the batteries in the receiver. A long beep means that the controller switch on the line between the receiver and the interrupter block (option) is in position „O“ or one of the wires connecting the receiver to the controller is not connected properly. Set the switch to „I“. If the control flame does not light, it is necessary to shut off the gas supply shut-off valve and contact a service technician. If, within six hours, the device does not receive a command from the user, a system of automatic gas control will reduce the main burner flame to the minimum. In the case of continuous operation without user intervention for five days after the last entry of settings, the system will turn off the unit and cut off the gas supply. Before the battery in the receiver is fully discharged, the controller will automatically shut off the gas supply to the stove.

Control

NOTE!!!

The remote control should always be kept out of the reach of children and other persons unaware, not capable of assessing the consequences of their actions.

The user gets the device along with the included remote control, type B6R-H9 (Fig. 17).



Fig. 17. B6R-H9 remote control

NOTE!!!

The B6R-H9 remote control units have a built-in sensor used in the thermostat mode. The unit continuously measures the ambient temperature and compares it with the temperature set on the thermostat. It should be kept in a dark place, to rule out measurement errors associated with direct sunlight.

NOTE!!!

Never use tools to change the position of knobs. Changing the position of the knobs can only be made by hand, otherwise you may damage the controller. In the case of locking the knobs, contact your service representative.





Gas Stove AB uses modern B6R-H9 remote controls set in accordance with the European standard for radio frequency 868MHz. The remote control supplied with the stove requires a new code transmission. To do it, in the first place, press and hold the „RESET“ button on the receiver until you hear two characteristic signals and then release the button. This operation should be done by means of the thin element with blunt ends. Further on, from the remote control, press and hold , until you hear two short beeps, indicating the remote control is synchronized with the receiver. One long beep indicates that the elements of the system have not been properly paired.



Figure 18. „RESET“ button - receiver

INFORMATION

To view the current version of the software used by the remote control, simultaneously press the  and . Simultaneous pressing the  button and the  button will display the remote control model.

Deactivating the remote control.

Install batteries. All available icons will appear on the display and will flash. During the flashing, press the appropriate icon for the function and hold it for 10 seconds. The icon appropriate for the selected button will flash until the end of the deactivation process. The remote control display shows the icon adequate for the selected function and two horizontal lines. If the function is deactivated two horizontal lines will appear on the display when pressing the button responsible for its selection. After replacing batteries, the settings will remain unchanged.

Activating the remote control.

Install batteries. All available icons will appear on the display and will flash. Press the appropriate icon for the function and hold it for 10 seconds. The icon appropriate for the selected button will flash until the end of the activation process. The remote control display shows the icon adequate for the selected function.

NOTE!!!

If, when you try to light it, the control flame goes out, wait for at least five minutes before trying again to light the stove.

NOTE!!!

If, after four attempts to light the stove, the control flame will not ignite, close the gas shut-off valve to the appliance and contact your service representative.

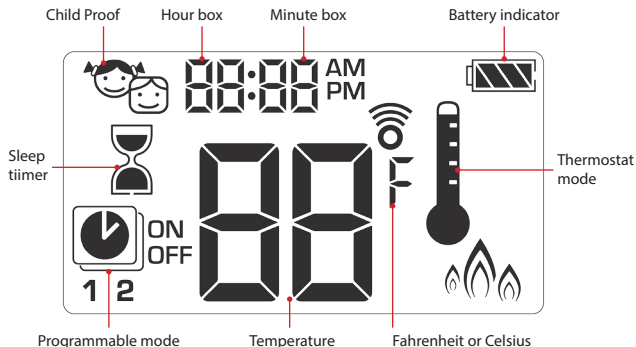
User manual of the 6-symbol B6R-H9 control unit**User manual of the 6-symbol B6R-H9 control unit**

To change the temperature unit, simultaneously press the buttons. You can choose between Celsius and Fahrenheit degrees. Choosing °F will automatically set the clock in a 12-hour format, while the choice of °C sets the clock in a 24-hour format.



**Time Setup**

- To be able to adjust the day of the week, press the button and the button.
- Press or to select a number corresponding to the day of the week (1 - Monday, 2 - Tuesday 3 - Wednesday 4 - Thursday, 5 - Friday, 6 - Saturday, 7 Sunday)
- Simultaneously press the button and the button. Hours will flash.
- Set the hour using the and buttons.
- Simultaneously press the button and the button. Minutes will flash.
- Set the minutes using the button and the button.
- To confirm the setting, simultaneously press and or wait.





Child Proof

Enabling:

To activate the Child Proof function press the  and  buttons. The display shows the  icon.

Disabling:

To deactivate the Child Proof function press the  and  buttons. The  icon will disappear.





Manual mode

Lighting the fire in the stove with a single button (default setting)

- Press the  button until you hear two short beeps. Starting the firing sequence is confirmed by the occurrence of a flashing icon on the display of the burner. Release the button.
- Kindling the control flame is confirmed by a single signal.
- After kindling the main burner, the remote control
- automatically switches to the manual mode.





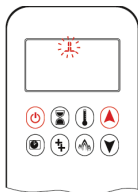

Lighting a fire in the stove with two buttons

- Simultaneously press the  button and the  button until you hear two short beeps. Starting the firing sequence is confirmed by the occurrence of a flashing icon on the display of the burner. Release the button.
- Kindling the control flame is confirmed by a single signal.
- After kindling the main burner, the remote control automatically switches to the manual mode.



Information:

To change the kindling method, immediately after you install the batteries in the remote control, hold the  button for 10 seconds. The remote control display shows „ON“ and a flashing digit corresponding to the current settings.

- 1 – Lighting a fire by pressing .
- 2 – Lighting a fire by pressing the  and the  buttons.

End of the procedure of changing the method of lightening a fire is confirmed with the display reading the appropriate number.

NOTE!!!

If, after several attempts to fire, ignition of the control flame does not take place, set the main valve knob to „OFF“ and refer to the section „Possible Problems and Solutions“.

Standby or off mode

To make the unit switch to the standby mode, hold the  button until the main burner is extinguished.

To turn the device off, press . The control flame will be extinguished.

Before attempting to re-start the stove, wait 5 seconds.



Adjusting the height of the flame

To increase the height of the flame, press and hold the  button.

To reduce the height of the flame or put the stove into the standby mode, press and hold .



Setting the minimum and maximum height of the flame

The minimum height of the flame

To reduce the burner flame to the minimum height, double-press the  button. The display shows the „LO“ symbol







The maximum height of the flame

To increase the burner to the maximum value, double-press the  button. The display shows the „HI“ symbol.



Sleep timer

Enabling/Settings

1. Press and hold  until you see the  icon. The hours' box will flash.
2. Enter a value using the  and  buttons.
3. To confirm, press . The minutes' box will flash.

4. Enter a value using the ▲ and ▼ buttons.
5. To confirm, press the ⏻ button or wait.

Disabling:

To deactivate the timer, press the ⏻ button the ⏻ icon will disappear with countdown time.



Information:

After the expiry of the countdown time, the stove will be extinguished. The sleep timer only works in different modes: Manual, Thermostat and Eco. The maximum value of the timer is 9 hours and 50 minutes.

Modes

Thermostat mode

The room temperature is measured and compared with the temperature set on the thermostat. The flame height is automatically adjusted so as to reach the set temperature.



Programmed mode

Programmes 1 and 2 can be freely modified. You can set the time on and off of the stove at a given temperature.



Tryb Eco



The flame height is adjustable between its extremes. If the room temperature is lower than the temperature preset on the thermostat, the flame height reaches its maximum value and remains at a high level for a longer period of time. If the room temperature is lower than the preset, the flame height is reduced to a minimum for a long period of time. One cycle takes approximately 20 minutes.







Thermostat mode

Enabling and disabling the thermostat

Enabling:





Press the  button. The display shows the icon  and the preset temperature as the first and the actual room temperature.

Disabling:

1. Press the  button.
2. Press the  button or the  button.
3. Press the  button, to enter the Programmed mode.





Thermostat settings

1. Press and hold  until you see the icon . The temperature displayed flashes.
2. To set the desired temperature use the  and  buttons.
3. To confirm, press  or wait.







Programmed mode

Enabling the programmed mode

Press the  button. The display shows the  icon and the 1 or 2 symbols and „ON“ and „OFF“.



Disabling the programmed mode

1. Press the  button or the  button, or  the button to go to the manual mode.
2. Press the  button, to go to the Thermostat mode.

Information:

Entering the switch-on temperature of the thermostat will automatically set the same value for the switch-on temperature of the programmed mode.







Default settings:

Temperature of switching on: 21°C

Temperature of switching ff: „-“ (only the control flame)





Temperature settings

1. Press and hold the  button until you see the flashing icon  „ON” and the switching off temperature will be displayed (set in the thermostat mode).
2. To continue, press  or wait. The display shows the  icon, the „OFF” symbol and a flashing value to symbolize the switching off temperature.
3. Set the desired temperature using the  or  buttons.
4. To confirm, press .



Setting the days









5. The display flashes „ALL”. Press the  button or the  button to select one of the three options to enter (ALL, SA:SU, 1, 2, 3, 4, 5, 6, 7).
6. To confirm, press .

SA:SU symbols, respectively, mean Saturday and Sunday. Individual numbers correspond to the days of the week (e.g. 1 Monday 2 - Tuesday 3 - Wednesday 4 - Thursday, 5 - Friday, 6 - Saturday, 7 - Sunday).



Switching on time settings (Programme 1)









„ALL” option selected

7. The display shows , 1, „ON”, then for a while you will see the „ALL” symbol. Subsequently, the hour will begin to flash.
8. Set the hour using the  and  buttons.
9. To confirm, press . The display shows the  icon, 1, „ON”, then for a while you will see the „ALL” symbol. Subsequently, the minutes will begin to flash.
10. Set the minutes using the  and  buttons.
11. To confirm, press .



Switching off time settings (Programme 1)

Wybrano opcję „ALL”

12. The display shows , 1, „OFF”, then for a while you will see the „ALL” symbol. Subsequently, the hour will begin to flash.
13. Set the hour using the  and  buttons.
14. To confirm, press . The display shows , 1, „ON”, then for a while you will see the „ALL” symbol. Subsequently, the minutes will begin to flash.
15. Set the minutes using the  and  buttons.
16. To confirm, press .



Information:

- Subsequently, the user can enter the time on and off for Programme 2. If not, Programme 2 will remain inactive.
- Temperature settings for enabling and disabling Programmes 1 and 2 are the same for all options (**ALL, SA: SU, 1, 2, 3, 4, 5, 6, 7**). Entering new settings for switching on and off temperatures automatically sets the default preset values.
- Entering new settings for switching on and off time for Programmes 1 and 2 will set new values as the default. To restore the factory settings for programmes 1 and 2, reset the remote control by removing the battery.

An optional auxiliary

This option is available only for gas stoves with more than one burner.

In the case of the AB stove series, the function remains inactive.

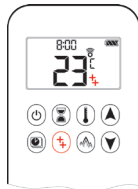
**Eco mode**

Switching on:

Press the  button. The display shows .

Wyłączenie:

Press the  button. The  icon disappears from the display.



Replacement of batteries

Batteries in the receiver, remote control or the power supply module can overheat, spill or even cause an explosion. Do not use batteries that have been exposed to the sun, moisture, heat or vibration. Install only batteries of the same type and the same manufacturer. Do not install new batteries with worn ones. The remote control is powered by two AAA batteries. The B6R-R8U receiver and the G60-ZB90 power module are powered by four AA batteries 1.5V. The battery life in the case of the remote control and the receiver is estimated at about 1 heating season. The device manufacturer recommends the use of alkaline batteries because of the lower risk associated with unsealing. It is also permissible to use rechargeable batteries. When removing batteries, do not use tools that can cause a short-circuit. Replacing batteries with conductive objects can permanently damage the electronic components of the remote control and the receiver.

Replacement of the batteries in the remote control:

- Remove the cover located on the rear of the remote control.
- Gently remove the used batteries from the remote control.
- Install new AAA batteries observing the polarity markings (+/-).
- Replace the cover on the back wall of the remote

Replacing batteries in the receiver/power supply module:

- Open the cabinet door panel.
- Carefully remove the B6R-R8U receiver/G60-ZB90 power module.
- Remove the cover.
- Remove the used four AA batteries and install new, paying attention to the polarity markings (+/-) on the receiver/power module.
- Replace the cover on the cover receiver/supply module.

NOTE!!!

Replacing batteries in the receiver/power supply module can only be done on a cool stove with the gas supply cut off.

NOTE!!!

Batteries are classified as hazardous chemical waste, so, after using them, they should not be disposed of with other household waste.

Maintenance

NOTE!!!

All maintenance work should be carried out on a cool stove with gas supply off and disconnected power supply.

NOTE!!!

Maintenance of the gas stove and the combustion air system can only be done by a qualified service technician.

- The device requires periodic inspection at least once a year.
- Cleaning the chimney system and a review should be conducted at least once a year.
- Glass with cracks and scratches should be immediately replaced with new ones.
- It is forbidden to make any changes in the design of the device.
- Stoves should not be cleaned with caustic agents.
- When replacing individual components, use only original spare parts available from the manufacturer.

Checklist:

L.p.	Zakres	Czynności
1	General inspection	<p>Perform lighting a fire in the stove. Check the operation of all safety systems. Check that the main burner flame burns steadily. Check that the main burner flame burns evenly. Check the batteries in the receiver and the remote control do not need to be replaced. Check the operation of all modes in the control unit.</p>
2	Glass inspection	<p>Make sure that the glass does not have any cracks. Make sure the glass fits tight to the body of the stove. Check the wear of the glass sealing cords. If necessary, replace the sealing cords. Check the degree of dirtiness of the glass. If necessary, clean the glass.</p>
3	Switch box inspection	<p>Check the tightness of gas connections. Make sure the switch box has adequate ventilation. Check that the cables connecting the controller to the receiver are not damaged. Make sure gas control system components are not exposed to high temperatures. Make sure that the switch box is not exposed to moisture. Check that the connecting cords have no signs of corrosion.</p>
4	Combustion chamber inspection	<p>Make sure the control burner is not obscured by decorative elements. Check if the thermocouple is within the control flame. Check whether the combustion chamber requires cleaning. Make sure all air inlets to the combustion chamber are clear. If necessary, clear the openings. Check the tightness of the body of the stove. Check the combustion chamber with respect to any signs of corrosion. If necessary, remove corrosion and cover losses with a new coating of paint. Check that the main burner ignites smoothly.</p>
5	Control of the chimney system	<p>If possible, check the tightness of the chimney system. Check the coaxial combustion air system patency.</p>
6	Control device inspection	<p>Check that the receiver antenna is not damaged. Make sure that the main valve knob and the manual mode dial work correctly. Check if there is no insulation damaged in the circuits. Make sure the AC power cord is not damaged. Make sure that the control system components are not exposed to overheating.</p>
7	Trim inspection	<p>Make sure the gas stove trim has no cracks. Make sure that combustible elements are at a safe distance from the stove trim.</p>
8	Decorative elements	<p>Make sure that decorative elements do not require cleaning. Make sure decorative elements are not in contact with the glass. Make sure that decorative elements are not damaged.</p>

WARNING!!!

Locking the pressure regulator is realized by the maximum tightening its adjusting screw.

Environmental protection

- If elements of the packaging in which the gas stove was supplied should be disposed of in an appropriate manner for their type.
- Due to the heavy metal included, the batteries are classified as hazardous chemical waste, so, after use, they should be thrown into special containers for hazardous waste.
- If the device operation is over, you should dispose of it. The user is obliged to submit the stove to an appropriate institution handling recycling this type of equipment.

Guarantee

FRAM GmbH grants you a guarantee of quality for the smooth functioning of the goods listed on the sales proof. The guarantee is given for the period from the date of purchase (based on the warranty card and/or the purchase document. The warranty period starts at the time of the original purchase of the product by the first end user. The product may consist of several different parts and the different parts will have different guarantee periods. The manufacturer offers a 2-year warranty for smooth operation from the date of purchase of the stove. Sealing of the stove will be warranted for a period of 1 year from the date of the purchase of the stove. The warranty does not cover: insulating panels, heat-resistant ceramics. The use of the stove, the connection method to the chimney and operating conditions must comply with the instructions. The basis for guarantee repairs, free of charge, is the product guarantee card. Any guarantee card without a date, stamps, signatures, as well as including any amendments made by unauthorized persons expires.

Customer powers under the guarantee will expire automatically: after the warranty period. Any damages caused by improper handling, storage, poor maintenance, incompatible with the conditions laid down in the operation and maintenance manual and due to other reasons not attributable to the manufacturer, will void the guarantee. For more information, please visit www.fram-gmbh.de.

POSSIBLE PROBLEMS AND SOLUTIONS

NOTE!!!

Removal of defects or replacement of system components for gas control can only be done by an authorized service technician.

There are many factors that could affect the gas stove malfunction. To exclude a possible fault in the unit or the automatic gas control system, be sure that the stove is connected in accordance with these instructions. The table below shows how to proceed in the case of individual symptoms.

NOTE!!!

Making replacement of damaged parts, use only original components offered by the manufacturer.

USTERKA	PROPONOWANE CZYNNOCI
The device will not start (no audible confirmation of the ignition procedure)	<ul style="list-style-type: none"> • Replace the batteries in the remote control and the receiver. • If the receiver is powered by the power module assess its performance. • Reset the receiver and program a new transmission code. • Make sure the receiver antenna is properly installed and not damaged.
No voltage on the controller coil (there are no specific „clicks“)	<ul style="list-style-type: none"> • Make sure the switch cord in the gas control module is not damaged. • Short cyclical signals appearing when you try to switch on the stove indicate the need to replace the batteries in the receiver. • For one long beep: <ul style="list-style-type: none"> - Make sure that the switch on the connecting cable from the gas control module with the receiver is set to „I“. (Option) - Check that the cable connecting the receiver to the gas control module is not damaged. - If the stepper motor is not working properly, replace the gas control module. - If the coil of the gas control unit is not working properly, replace the module. - If the micro-switch of the gas control module is not working properly, replace the module
No spark at the electrode	<ul style="list-style-type: none"> • Check the cable connection between the receiver and the electrode. • Check that the electrode is not damaged. • Check the operation of the sparkler. • Check that there is no system breakdown. • If the ignition components are working properly and the firing procedure does not start: <ul style="list-style-type: none"> - Press the „RESET“ button on the receiver. - If it is possible, shorten the cable between the receiver and the electrode. - Add a grounding cable between the controller and the control burner.
No control flame	<ul style="list-style-type: none"> • Make sure that the gas shut-off valve is open. • Repeatedly make attempts to ignite the stove. • Check that the pressure in the gas installation is appropriate. • Check the connection between the breaker and the receiver.
After lighting the control flame, spark still appears at the electrode	<ul style="list-style-type: none"> • Check the connection between the breaker and the controller. • In the case of damage to the electronic amplifier, replace the receiver.
The control flame extinguishes automatically	<ul style="list-style-type: none"> • Make sure the thermocouple sensor is operating and properly connected to the gas control module. • Make sure the flame control is capable of heating the temp. sensor. • Check that the gas valve of the gas control module is not damaged.
Weak control flame	<ul style="list-style-type: none"> • Check the gas pressure in the control flame.

<p>The main burner does not ignite</p>	<ul style="list-style-type: none"> • Make sure the holes of the main burner are not blocked. • Make sure the manual mode dial is set to the „ON“ position. • Check the control flame intensity. • Make sure the control flame control is not blocked with decorations. • Make sure the thermocouple sensor is operating and properly connected to the gas control module. • Make sure the flame control is capable of heating the temp. sensor.
<p>The main burner automatically turns off after the stove reaches a certain temperature</p>	<ul style="list-style-type: none"> • Check the thermostat setting.
<p>There is sediment deposited on the glass</p>	<ul style="list-style-type: none"> • Make sure the holes of the main burner are not blocked. • Check that the gas pressure in the installation is correct. • Check that nothing blocks the chimney system.
<p>The device cannot be turned off using the remote control</p>	<ul style="list-style-type: none"> • Try turning off the burner using the switch on the gas control module, setting it to „O“. If there is no response, replace the gas control module. • Check the connection between the breaker and the controller.

ILLUSTRATIONS

Correct arrangement of decorative logs



Fig. 19. Correct arrangement of decorative logs



Fig. 20. Correct arrangement of decorative logs

Technical Specification

		I2E(20), I2H(20)	I2L(25)	I2E+(20/25)	I3B/P(30)
Gas group		G20	G25	G20/G25	
Type		NG			
Nominal connection pressure	[mbar]	20	25	20/25	30
Gas pressure behind the regulator for the rated load	[mbar]	19,0	23,5	19,0/23,5	
		Regulator Blocked			
Gas pressure behind the regulator for minimum load	[mbar]	5,0	6,5	5,0/6,5	
Rated thermal load, according to H_i	[mbar]	5,2	5,2	5,2	
Rated minimum load, according to H_i	[mbar]	2,7	2,7	2,7	
Consumable gas stream for rated (maximum) heat load	[m ³ /h]	0,57	0,62	0,57/0,62	
Gas consumption for minimum heat load	[m ³ /h]	0,29	0,32	0,29/0,32	
Efficiency class	[-]	2	2	2	
NOx concentration class	[-]	4	4	4	5
Gas nozzle	[mm]	1,90	1,90	1,90	
Gas nozzle designation	[-]	NG1.9	NG1.9	NG1.9	

Stove category						
I3B/P(37)	I3B/P(50)	I3P(30)	I3P(37)	I3P(50)	I3+(30/37)	
G30		G31			G30/G31	
LPG						
37	50	30	37	50	30/37	
22,0		24,0			29,7/36,5	
					Regulator Blocked	
5,5		6,0			13,0/15,0	
4,5		4,5			4,4	
2,3		2,3			2,7	
0,14		0,18			0,14/0,17	
0,07		0,09			0,09/0,11	
2		2			2	
5	5	4	4	4	5	
1,20		1,30			1,15	
LPG1.2		LPG1.3			LPG1.15	

FRAM
GmbH

FRAM GmbH
Industriestraße 12/22
49324 Melle
www.fram-gmbh.de